

SUGGESTED USES

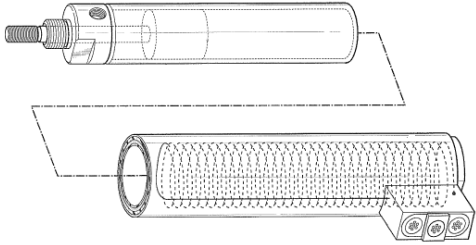

Slide-over style cylinder sensor

US PATENTS:
7,847,541
8,710,828

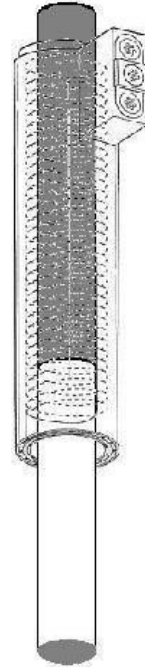

Slide-over sensor can be mounted, and a free-floating two-material tube creates a fluid level sensor.

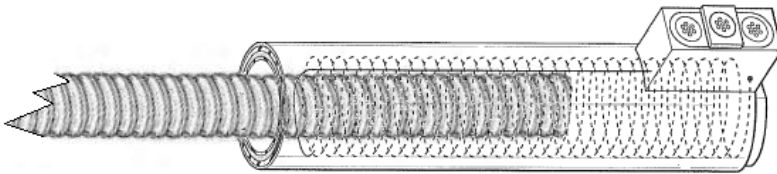

Slide-over sensor can be mounted to sense the position of a protruding leadscrew.

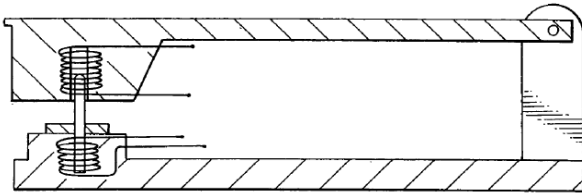

Piano key configured with twin-coil design to sense key motion.

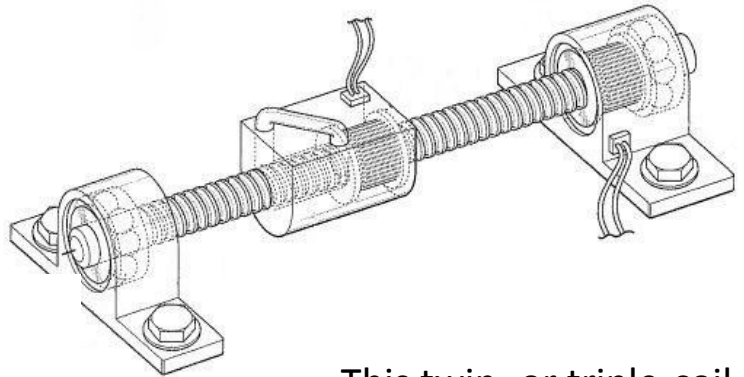

This twin- or triple-coil design senses position on lead screws continuously, end-to-end.

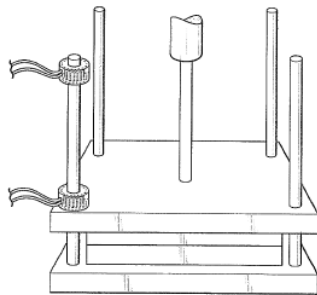
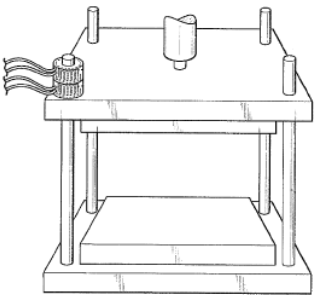

This twin-coil design works for a press or plastic injection molder.

www.meiselectric.com

105 North Marias Clawson, Michigan 48017 248-729-7370